

# KOLP

KOSMEK OVERLOAD PROTECTION SYSTEMS

**PH**  
**PL**  
**PV**  
**PW**  
**ETCETERAS**

English



# DRAWINGS

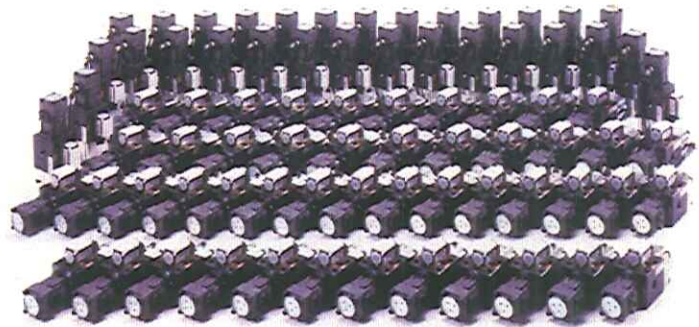

**KOSMEK®**

## KOLP(KOSMEK OVERLOAD PROTECTION SYSTEM )

with high responsiveness and stability is now becoming essential system to maximize the press capacity and to enable to use the press safely and efficiently.

More than 20,000 sets of this system have been already shipped.

**KOSMEK** manufactures and sells various types of equipment having excellent hydraulic performance based on superiority of sealing technology. Experience obtained from production and sales of a number of equipment has been integrated into the compact system **KOLP**.

### ■ Features

Overload pressure setting is easy and correct.

Shock resistance of the switch is more than 70G.

Pilot valve action is directly connected to the limit switch. An emergency stop signal is sent to the press at the same time when hydraulic oil is discharged.

Response time is less than 1 msec.

Even if an amount of overload (overload stroke length) increases, the action accuracy of **KOLP** is kept within +10% and the repetitive accuracy within  $\pm 3\%$ .

Compact and light weight.

A number of series can deal with the press machines from small size (200 kN) to large one (20,000 kN).

High accuracy of the press is kept by adding optimum preload and minimizing strain due to hydraulic oil compression during the normal operation.

### KOLP Performance Data (Example)

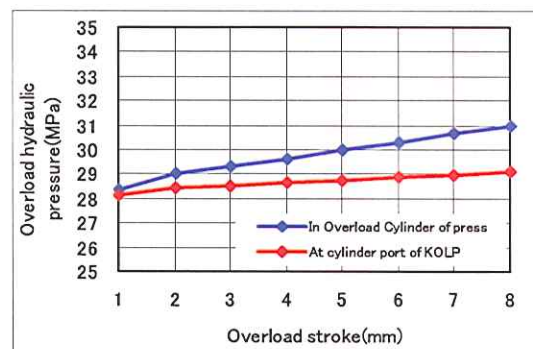
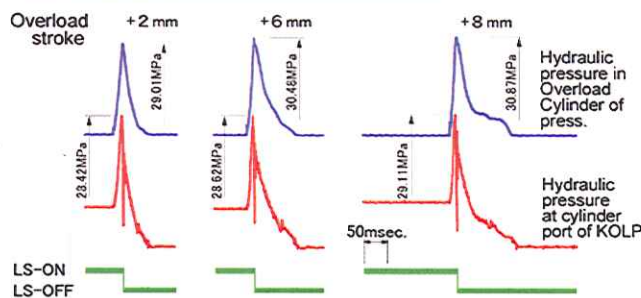

- Many types of peripheral equipment for the press such as PF type of Overload Protection Valve, Jamming Release Unit, Load Monitor, Breakthrough Simulator, AA and AB Pumps are available (See P.15).

#### ■ Industrial Property (Relating to KOLP)

	Domestic	Overseas
Pending	10	23
Obtained	7	25

## ■ Applicable range of **KOLP** to the press and outline of construction

- The optimum equipment can be selected from total 10 types of **KOLP** consisting of three sizes for each of four models according to the condition of the press.

\*1. A pump for supplying preload pressure to the press (Overload Cylinder) is built in Types 10 and 16. However the pump must be purchased separately for Type 35 (to be installed separately).

Targeted press capacity (kN)	Model	Standard type		Multi-load type	
		Air type (Variable operating pressure)	Spring type (Constant operating pressure)	Air type (Variable operating pressure)	Spring type (Constant operating pressure)
~2000	Size	PH10	PL10	—	—
~6000		PH16	PL16	PV16	PW16
~20000		PH35*1	PL35*1	PV35*1	PW35*1

## ◆ **KOLP** consists of the following items:

**KOLP** consisting of a pump, valves, a bleeding valve and a pressure switch realizes high response (high sensitivity) and high quality (high accuracy) action and simultaneously prevents the erroneous operation of the press caused by the machine temperature rise to stabilize the press capacity and performance. When overload (Press capacity × approx. 1.1 = Overload of 110%) is generated during press work, the system prevents the press and the die from being subjected to an excessive load. In comparison with the mechanical type such as shear plate one, the system brings effects such as performance stability and reduction of recovery work time.

## ◆ **PH** circuit diagram

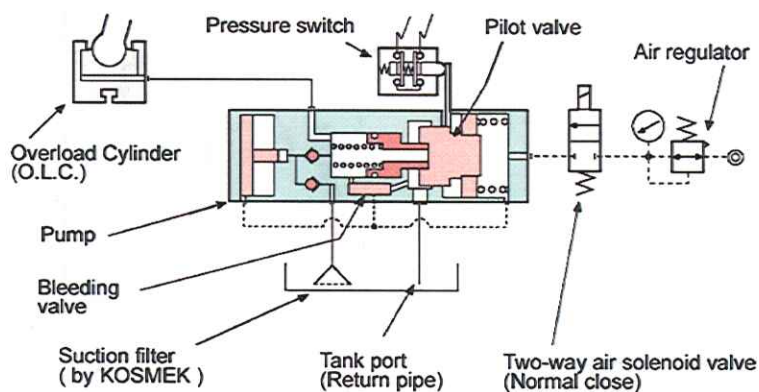

## ◆ Function of **KOLP**

**KOLP** detects rapid pressure rise in the Overload Cylinder installed in the slide of the press, instantly discharges hydraulic oil and sends an emergency stop signal to the press. The press instantly stops by this signal and shuts off air supply to **KOLP**.

## ◆ **PL** circuit diagram

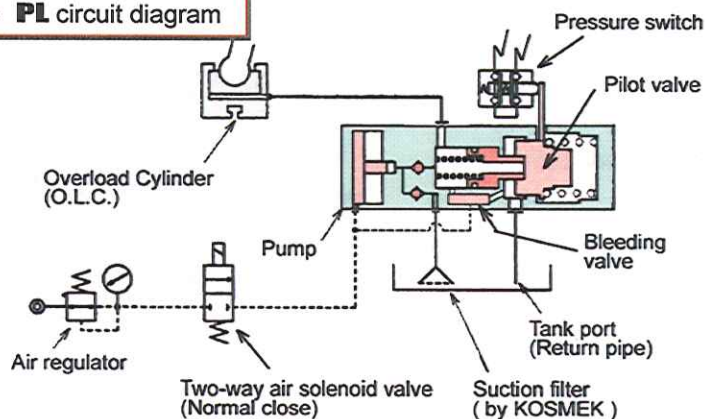

## ◆ **KOLP** facilitates recovery work.

- ① The recovery after the **KOLP** actuation is very easy.
- ② In order to recover, switch the press operation mode to "Inching," return the slide to the top dead point, remove the cause of the overload generation, secure safety and reset the emergency stop.
- ③ Supply air to **KOLP** to charge preload pressure in Overload Cylinder, and wait the pressure reaches the set value, which means the press is ready for operation.

## ■ Performance (taking air type as an example)

### I. Press operation preparation

Supply air pressure to **KOLP** and preload pressure to Overload Cylinder (OLC).

- ① The pump is actuated by the air supply, and the main and pilot valves move rightward against spring force along with the preload pressure rise.
- ② All the limit switch contacts are turned ON to release an emergency stop signal to the press.  
Press reset button to restart. Fig.②

### II. Overload actuation

- ③ When the press is subjected to overload, OLC is compressed to further increase preload pressure. When this pressure exceeds the set value, the pilot valve moves rightward to instantly discharge overload pressure into a tank. Along with this action, movement of the pilot valve releases the limit switch contact. Then "OFF" signal is sent to the press to provide an emergency stop and shut off air supply to **KOLP**.  
Fig.③

- ④ After the **KOLP** actuation, the main and pilot valves are pushed back by the spring force along with the internal pressure reduction. Fig.④
- ⑤ The press operation is kept in a disabled condition with the limit switch still turned OFF. Fig.④

- ※ Return the press slide till the top dead point by "Inching." Fig.④
- ※ Remove the cause of overload and press the reset button to supply air to **KOLP**.  
OLC is supplied with the preload pressure again and return to operation preparation mode.  
Fig.① to Fig.②

Fig.①

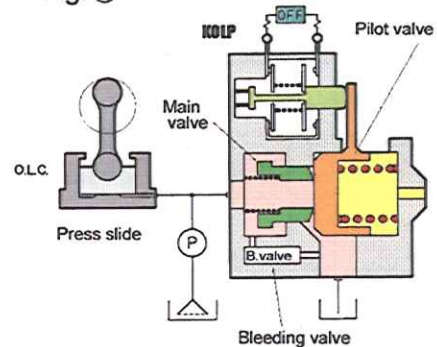

Fig.②

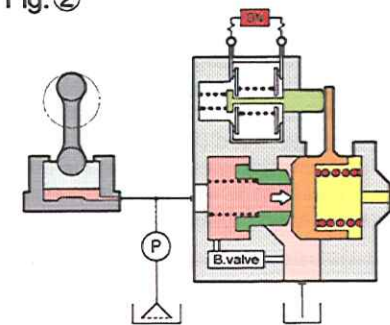

Fig.③

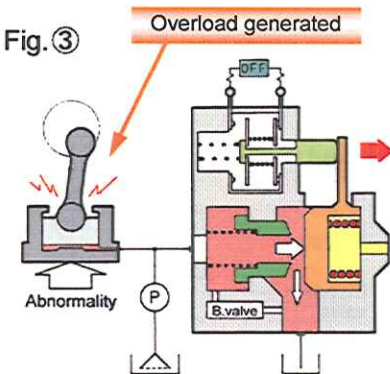
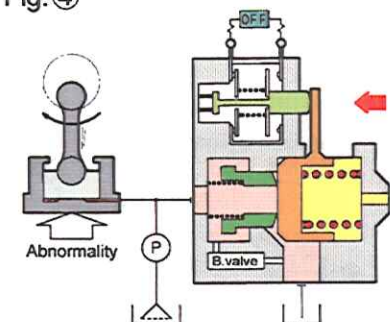

Fig.④



## ■ KOLP (PV/PW) applicable to multi-load — for 2-point and 4-point presses

★ The press with wide slide such as double crank press is subjected to deviated load when the mold position is deviated or the mold load is unstable at the start of press work (at material supply). PV/PW KOLP applicable to deviated load uses Overload Cylinders independently and instantly release both cylinders with high responsiveness and high accuracy to prevent overload of the press when one of two cylinders is subjected to overload.



In case standard type overload protection system is directly connected to cylinder

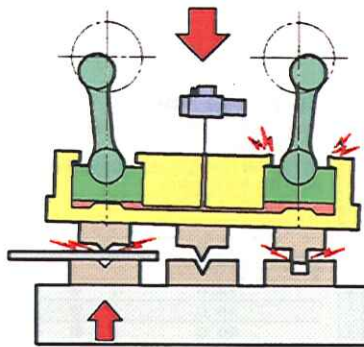

After hydraulic pressure raised by the load acting on one of two cylinders flows into the other cylinder, the overload protector is actuated.

In case the overload protection system PV/PW applicable to multi-load is used

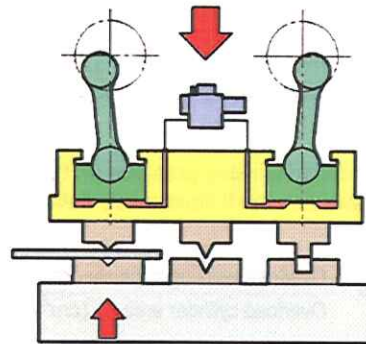

Even if one cylinder is subjected to load, the raised hydraulic pressure in Overload Cylinder does not flow into the other cylinder. Even if overload is generated in one cylinder, the overload protection system is actuated to release both cylinders at the same time.

### ■ General circuit

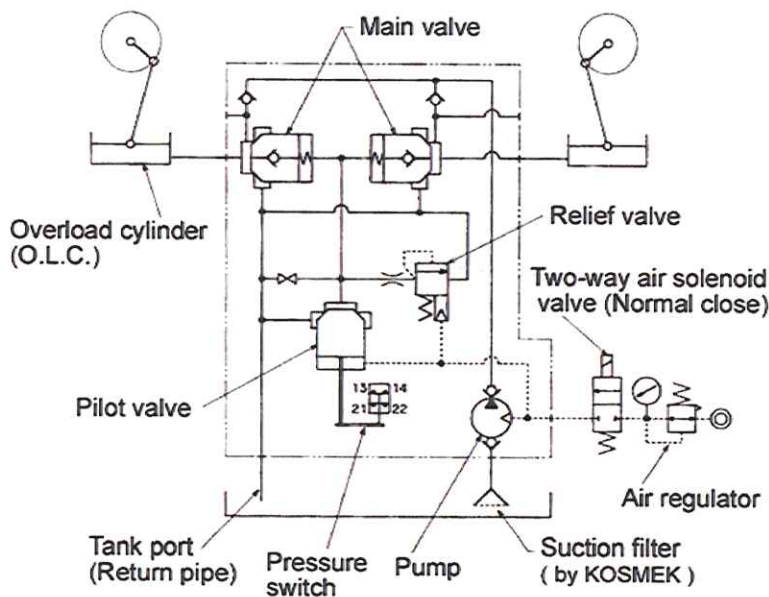

### ■ Performance

- ① PV (PW) has a main valve for each Overload cylinder (OLC) individually.
- ② When the press is subjected to a deviated load, hydraulic pressure inside OLC rises and opens the pilot valve through the check valve of the appropriate main valve.
- ③ At this time, check valve function prevents hydraulic pressure in other OLC from rising.
- ④ When the pilot valve opens, both main valves open at the same time to discharge hydraulic oil from both OLCs.
- ⑤ The above instant action protects the press function even if the deviated load is generated.
- ⑥ And when the main valve opens, a pressure switch is turned OFF to send an emergency stop signal to the press.

## ■ KOLP type selection procedure

**KOLP** type is selected using the approximate value obtained from calculation of necessary functions based on the performance and specifications of the press. You can perform the calculation according to the procedure below to place an order, or inform us of your requirements.

### ★ Setting condition

#### ① Air supply pressure (PA)

1. Set the air supply pressure at the value that can be guaranteed by user.
2. When KOLP is commonly used with air circuit of clutch brake or balancer, set at that value.
3. Set the air pressure in the range of 0.3 - 0.5 MPa.

#### ② Overload working capacity (Cp)

1. Assume the overload working capacity as approximately 110% of normal press capacity (nominal).
2. Determine the value within 100 - 120% depending on the workpiece property and the press rigidity.

### ★ Obtain overload working pressure (PH).

Determine based on the following calculation results:

$$PH(\text{MPa}) = \frac{\text{Overload working capacity (kN)}}{\text{Overload cylinder area (cm}^2)} \times 10 = \frac{C_p}{A} \times 10$$

\* In case of air type, select "Pressure code" from "Overload pressure setting range" to calculate the setting value of air supply pressure (PA).

\* In case of spring type, select approximate pressure from the values of standard overload pressure.

### Notes for pressure determination

- ① Set air pressure (PA) as high as possible.
- ② Set overload working pressure (PH) as high as possible.
- ③ Unify the working pressure of all types of the press to commonly use **KOLP**.

### ★ Check the discharge flow rate during overload actuation.

Adjust flow rate from Overload Cylinder to be lower than the rating flow rate of Overload Protection Valve (See the "**KOLP** rating flow rate" table below).

How to calculate the Overload Cylinder flow rate:

$$Q = A \times V \times \frac{1}{10}$$

$$V = \frac{2\pi N}{60} \sqrt{L \cdot Y - Y^2} \times Z$$

- Q: Overload Cylinder discharge flow rate      cm<sup>3</sup>/s
- A: Overload Cylinder area      cm<sup>2</sup>
- V: Slide lowering speed at the position where the optimum press capacity is available      mm/s
- N: Number of press strokes      spm
- L: Stroke length      mm
- Y: Position where the optimum press capacity is available (From the bottom point)      mm
- Z: Factor (1.1)

### Air type KOLP

Press. code	Overload press. setting range (MPa)	Calculation formula for setting value of KOLP air supply press. PA (MPa)
5	18~25	$\frac{(PH \times 87.6) - 715.4}{2922.5}$
6	22~30	$\frac{(PH \times 73.0) - 715.4}{2922.5}$
7	25~35	$\frac{(PH \times 62.5) - 715.4}{2922.5}$

\* Preload pressure for H type is 18 - 22 MPa.

### Spring type KOLP

Note: Mark ● shows the model that can be manufactured.

In case of spring type, it is recommended to select from the table below.

Overload standard working press. (MPa)	Press. code		
	5	6	7
16.0	●		
17.0	●		
18.0	●	●	
19.0	●	●	
20.0	●	●	●
21.2	●	●	●
22.5	●	●	●
23.5	●	●	●
25.0	●	●	●
26.5		●	●
28.0		●	●
30.0		●	●
31.5			●
33.5			●
35.5			●

\* Unification of the overload pressure at the press design stage facilitates the equipment control.

### KOLP rating flow rate

Unit: cm<sup>3</sup>/s

		Pressure code		
		5	6	7
Body size	10	18,500	17,000	15,500
	16	44,000	48,000	52,000
	35	200,000	210,000	220,000

## ■ KOLP type selection procedure (Example)

Body size of **KOLP** can be roughly selected according to the press capacity. However in order to select the optimum type, it is necessary to calculate necessary functions based on the press specifications to obtain the approximate value.

A calculation example according to the procedure shown in the previous page is shown below.

## ■ General relation between body size and press capacity

KOLP	Body size		
	10	16	35
Press capacity (kN)	~2000	~6000	~20000

Note:

The above information is only for reference. Be sure to calculate based on the actual specifications to select the type suitable for the press capacity for each case.

### ☆ Calculation example (5000 kN Press)

Item	Specification	Symbol	
Air supply press. (guaranteed)	MPa	0.55	
Air press. for clutch brake and balancer	MPa	0.50	Pa
Press capacity	kN	5000	
Number of stroke	spm	25	N
Stroke length	mm	300	L
Optimum capacity generating position	mm	13 mm above the bottom dead point	Y
Overload cylinder diameter	mm	350 × 2	

#### ① Overload working pressure

$$PH = \frac{C_p}{A} \times 10 = \frac{5000 \times 1.1 \times 10}{35^2 \times \pi / 4 \times 2} = 28.6 \text{ MPa}$$

In case of air type  
Overload working pressure  
KOLP pressure code "6" is temporarily assumed.  
Air supply pressure is calculated using the formula of the right table, and  
Air pressure = 0.47 MPa is obtained.

In case of spring type  
Overload standard working pressure 28.0 MPa and KOLP pressure code "6" are temporarily assumed in the right table.

#### ② Overload discharge flow rate

$$V = \frac{2\pi N}{60} \sqrt{L \cdot Y - Y^2} \times Z$$

$$= \frac{2\pi \times 25}{60} \sqrt{300 \times 13 - 13^2} \times 1.1$$

$$= 175.9 \text{ mm/s}$$

$$Q = A \times V \times \frac{1}{10} = 35^2 \times \pi \div 4 \times 2 \times 175.9 \times \frac{1}{10}$$

$$= 33,847 \text{ cm}^3/\text{s}$$

∴ The calculation result of the above calculation is compared with the right "KOLP rating flow rate" table to select the body size "16 type" and the pressure code "6," namely  
in case of air type: PH1660  
in case of spring type: PL1663

### Air type KOLP

Press. code	Overload press. setting range (MPa)	Calculation formula for setting value of KOLP air supply press. PA (MPa)
5	18~25	$\frac{(PH \times 87.6) - 715.4}{2922.5}$
6	22~30	$\frac{(PH \times 73.0) - 715.4}{2922.5}$
7	25~35	$\frac{(PH \times 62.57) - 715.4}{2922.5}$

\* Preload pressure for H type is 18 - 22 MPa.

### Spring type KOLP

Note: Mark ● shows the model that can be manufactured.

In case of spring type, it is recommended to select from the table below.

Overload standard working press. (MPa)	Press. code		
	5	6	7
16.0	●		
17.0	●		
18.0	●	●	
19.0	●	●	
20.0	●	●	●
21.2	●	●	●
22.5	●	●	●
23.5	●	●	●
25.0	●	●	●
26.5		●	●
28.0		●	●
30.0		●	●
31.5			●
33.5			●
35.5			●

\* Unification of the overload pressure at the press design stage facilitates the equipment control.

### KOLP rating flow rate

Unit: cm<sup>3</sup>/s

Body size	Pressure code		
	5	6	7
	10	18,500	17,000
16	44,000	48,000	52,000
35	200,000	210,000	220,000

# PH Series

# KOLP



Air type standard model

## MPa

### Model designation

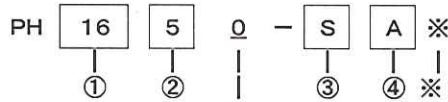

※ is our control number.  
Compatible even if this number is different.

- ① Body size (Orifice area)
  - 10 : See specification
  - 16 : 2.0 cm<sup>2</sup>
  - 35 : 9.6 cm<sup>2</sup>
- ② Overload pressure code (Max. value)
  - 5 : 25 MPa
  - 6 : 30 MPa
  - 7 : 35 MPa
- ③ Preload pressure
  - S : Standard
  - H \*1 : High pressure (Special)
- ④ Cylinder port direction ※As for body size "35,"
  - A : One this direction not shown\*2
  - G : Two

Press. code	Overload press. setting range (MPa)	Calculation formula for setting value of KOLP air supply press. PA (MPa)
5	18~25	$\frac{(PH \times 87.6) - 715.4}{2922.5}$
6	22~30	$\frac{(PH \times 73.0) - 715.4}{2922.5}$
7	25~35	$\frac{(PH \times 62.57) - 715.4}{2922.5}$

\* Preload pressure for H type is 18 - 22 MPa.

### Remarks

- \*1: Whenever H type is desirable, consult us for detail.
- \*2: All the models of body size 35 have two cylinder ports.

### Specifications

Body size		10			16			35			
Dimension (X×Y×Z) mm		219×92×102.5			280×107×104			247×135×136.8			
Overload pressure code		5	6	7	5	6	7	5	6	7	
Orifice area cm <sup>2</sup>		0.85	0.70	0.60	2			9.6			
Rating flow rate cm <sup>3</sup> /s		18500	17000	15500	44000	48000	52000	200000	210000	220000	
Overload pressure setting range MPa		S	18~25	22~30	25~35	18~25	22~30	25~35	18~25	22~30	25~35
		H	18~22			18~22			18~22		
Air supply press. MPa	Preload press.	S	0.3~0.5			0.3~0.5			0.3~0.5		
		H	0.3~0.4	0.3~0.5		0.3~0.4	0.3~0.5		0.3~0.4	0.3~0.5	
Pump discharge press. MPa		S	24.5 × (Air pressure - 0.05)			24 × (Air pressure - 0.04)			-		
		H	39.5 × (Air pressure - 0.05)			38 × (Air pressure - 0.04)			-		
Operating temperature		-5~70°C (However freezing not allowable)									
Operating fluid		ISO-VG-15~ISO-VG-32									
Mass kg		4			6			21			

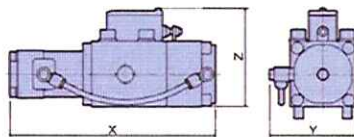

PH10, PH16

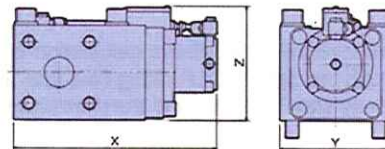

PH35  
(Pump is optional)

※ See the separate outline drawing for detail dimension.



# PL Series

# KOLP

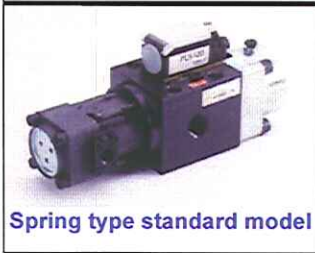

Spring type standard model

## Model designation

PL 10 6 3 - S 300 P A ※

①      ②      ③      ④      ⑤      ⑥      ⑦

**MPa**

※ is our control number.  
Compatible even if this number is different.

④ Overload standard setting press.  
Select from the table below. Unification of the overload pressure at the press design stage facilitates the equipment control.

Note: Mark ● shows the model that can be manufactured.

Overload standard working pressure (MPa)	Press. code		
	5	6	7
16.0	●		
17.0	●		
18.0	●	●	
19.0	●	●	
20.0	●	●	●
21.2	●	●	●
22.5	●	●	●
23.5	●	●	●
25.0	●	●	●
26.5		●	●
28.0		●	●
30.0		●	●
31.5			●
33.5			●
35.5			●

- ① Body size (Orifice area)
  - 10 : See specification
  - 16 : 2.0 cm<sup>2</sup>
  - 35 : 9.6 cm<sup>2</sup>
- ② Overload pressure code (Max. value)
  - 5 : 25 MPa
  - 6 : 30 MPa
  - 7 : 35 MPa
- ③ Design No.
  - 0 : Body size 10, 35
  - 3 : Body size 16
- ④ Preload pressure
  - S : Standard
  - H\*1 : High pressure (Special)
- ⑤ Overload setting pressure (The first decimal place is indicated in MPa value)
  - ex.: 235 : 23.5 MPa
  - 300 : 30.0 MPa
- ⑥ Unit selection ※ SI unit (MPa) is recommended for a new order.
  - P : MPa
- ⑦ Cylinder port direction ※As for body size "35," this direction not shown\*2
  - A : One
  - G : Two

### Remarks

\*1 : Whenever H type is desirable, consult us for detail.

\*2 : All the models of body size 35 have two cylinder ports.

## Specifications

Body size		10			16			35				
Dimension (X×Y×Z) mm		219×70×102.5			280×82.5×104			247×135×136.8				
Overload pressure code		5	6	7	5	6	7	5	6	7		
Orifice area cm <sup>2</sup>		0.85	0.70	0.60	2			9.6				
Rating flow rate cm <sup>3</sup> /s		18500	17000	15500	44000	48000	52000	200000	210000	220000		
Overload pressure setting range MPa	S	Air supply pressure for pump	0.4	16~25	18~30	20~35.5	16~25	18~30	20~35.5	16~25	18~30	20~35.5
		0.45										
		0.5	18~25			18~25			18~25			
	H	0.35	-	18~30	20~35.5	-	18~30	20~35.5	-	18~30	20~35.5	
		0.4	-	21.2~30	21.2~35.5	-	21.2~30	21.2~35.5	-	21.2~30	21.2~35.5	
		0.45	-	23.5~30	23.5~35.5	-	23.5~30	23.5~35.5	-	23.5~30	23.5~35.5	
0.5	-	26.5~30	26.5~35.5	-	26.5~30	26.5~35.5	-	26.5~30	26.5~35.5			
Air supply press. MPa	Preload press.	S	0.4~0.5			0.4~0.5			-			
		H	0.35~0.5			0.35~0.5			-			
Pump discharge press. MPa	S	24.5×(Air pressure -0.05)			24×(Air pressure -0.04)			-				
	H	39.5×(Air pressure -0.05)			38×(Air pressure -0.04)			-				
Operating temperature		-5~70°C(However freezing not allowable)										
Operating fluid		ISO-VG-15~ISO-VG-32										
Mass kg		4			6			21				

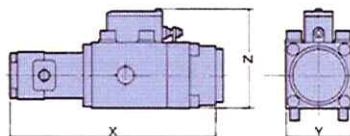

PL10, PL16

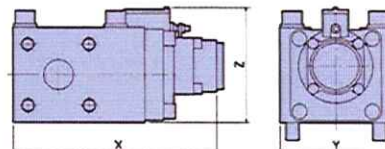

PL35  
(Pump is optional)

※ See the separate outline drawing for detail dimension.

# PL Series

# KOLP

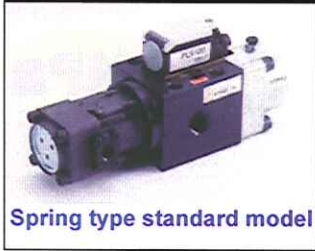

**kgf/cm<sup>2</sup>**

### Model designation

PL 10 6 Q - S 300 K A ※

①      ②      ③      ④      ⑤      ⑥      ⑦

※ is our control number. Compatible even if this number is different.

④ Overload standard setting press. Select from the table below. Unification of the overload pressure at the press design stage facilitates the equipment control.

Note: Mark ● shows the model that can be manufactured.

Overload standard working pressure ( kgf/cm <sup>2</sup> )	Press. code		
	5	6	7
160	●		
170	●		
180	●	●	
190	●	●	
200	●	●	●
212	●	●	●
225	●	●	●
235	●	●	●
250	●	●	●
265		●	●
280		●	●
300		●	●
315			●
335			●
355			●

- ① Body size (Orifice area)
  - 10 : See specification
  - 16 : 2.0 cm<sup>2</sup>
  - 35 : 9.6 cm<sup>2</sup>
- ② Overload pressure code (Max. value)
  - 5 : 250 kgf/cm<sup>2</sup>
  - 6 : 300 kgf/cm<sup>2</sup>
  - 7 : 355 kgf/cm<sup>2</sup>
- ③ Design No.
  - 0 : Body size 10, 35
  - 3 : Body size 16
- ④ Preload pressure
  - S : Standard
  - H\*1 : High pressure (Special)
- ⑤ Overload setting pressure (Three digits are indicated in kgf/cm<sup>2</sup> value.)
  - ex.: 235 : 235 kgf/cm<sup>2</sup>
  - 300 : 300 kgf/cm<sup>2</sup>
- ⑥ Unit selection ※ SI unit (MPa) is recommended for a new order.
  - K : kgf/cm<sup>2</sup>
- ⑦ Cylinder port direction ※As for body size "35," this direction not shown\*2
  - A : One
  - G : Two

### Remarks

- \*1 : Whenever H type is desirable, consult us for detail.
- \*2 : All the models of body size 35 have two cylinder ports.

### 仕様

Body size		10			16			35				
Dimension (X×Y×Z) mm		219×70×102.5			280×82.5×104			247×135×136.8				
Overload pressure code		5	6	7	5	6	7	5	6	7		
Orifice area cm <sup>2</sup>		0.85	0.70	0.60	2			9.6				
Rating flow rate cm <sup>3</sup> /s		18500	17000	15500	44000	48000	52000	200000	210000	220000		
Overload pressure setting range kgf/cm <sup>2</sup>	S	Air supply pressure for pump	4	160~250	180~300	200~355	160~250	180~300	200~355	160~250	180~300	200~355
			4.5	180~250			180~250			180~250		
			5	180~250			180~250			180~250		
			3.5	-	180~300	200~355	-	180~300	200~355	-	180~300	200~355
			4	-	212~300	212~355	-	212~300	212~355	-	212~300	212~355
H	Air supply pressure for pump	4	-	212~300	212~355	-	212~300	212~355	-	212~300	212~355	
		4.5	-	235~300	235~355	-	235~300	235~355	-	235~300	235~355	
		5	-	265~300	265~355	-	265~300	265~355	-	265~300	265~355	
		4	-	212~300	212~355	-	212~300	212~355	-	212~300	212~355	
		4.5	-	235~300	235~355	-	235~300	235~355	-	235~300	235~355	
Air supply press. kgf/cm <sup>2</sup>	Preload press.	S	4~5			4~5			-			
		H	3.5~5			3.5~5			-			
Pump discharge press. kgf/cm <sup>2</sup>	Preload press.	S	24.5×(Air pressure -0.05)			24×(Air pressure -0.04)			-			
		H	39.5×(Air pressure -0.05)			38×(Air pressure -0.04)			-			
Operating temperature		-5~70°C(However freezing not allowable)										
Operating fluid		ISO-VG-15~ISO-VG-32										
Mass kg		4			6			21				

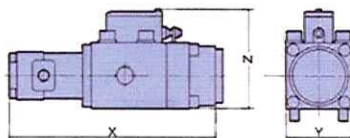

PL10, PL16

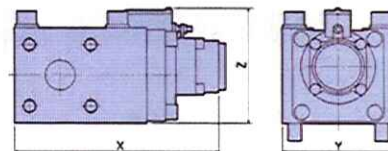

PL35  
(Pump is optional)

※ See the separate outline drawing for detail dimension.

# PV Series

# KOLP



Air type multi-load model

## MPa

### Model designation

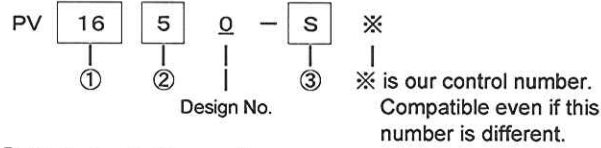

① Body size (Orifice area)

- 16 : 1.0 cm<sup>2</sup> × 2
- 35 : 4.9 cm<sup>2</sup> × 2

② Overload pressure code (Max. value)

- 5 : 25 MPa
- 6 : 30 MPa
- 7 : 35 MPa

③ Preload pressure

- S : Standard
- H \*1 : High pressure (Special)

Press. code	Overload press. setting range ( MPa )	Calculation formula for setting value of KOLP air supply press. PA ( MPa )
5	18~25	$\frac{(PH \times 87.6) - 715.4}{2922.5}$
6	22~30	$\frac{(PH \times 73.0) - 715.4}{2922.5}$
7	25~35	$\frac{(PH \times 62.57) - 715.4}{2922.5}$

\* Preload pressure for H type is 18 - 22 MPa.

### Remarks

\*1 : Whenever H type is desirable, consult us for detail.

### Specifications

Body size		16			35			
Dimension (X×Y×Z) mm		321.5×130.5×104			200×160×135			
Overload pressure code		5	6	7	5	6	7	
Orifice area cm <sup>2</sup>		1×2			4.9×2			
Rating flow rate cm <sup>3</sup> /s		22,000×2	24,000×2	26,000×2	100,000×2	105,000×2	110,000×2	
Overload pressure setting range MPa		S	18~25	22~30	25~35	18~25	22~30	25~35
		H	18~22			18~22		
Air supply press. MPa		Preload press.	S	0.3~0.5		0.3~0.5		
			H	0.3~0.4	0.3~0.5	0.3~0.4	0.3~0.5	
Pump discharge press. MPa		S	24×(Air pressure -0.04)					
		H	38×(Air pressure -0.04)					
Operating temperature		-5~70°C(However freezing not allowable)						
Operating fluid		ISO-VG-15~ISO-VG-32						
Mass kg		10			20			

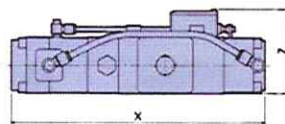

PV16

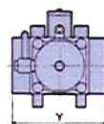

PV35  
(Pump is optional)

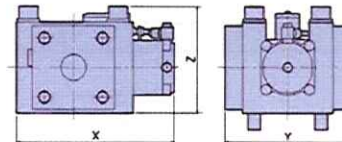

※ See the separate outline drawing for detail dimension.

# PW Series



Spring type multi-load model

# KOLP

## MPa

### Model designation

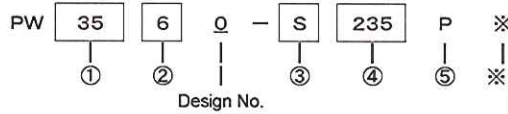

※ is our control number.  
Compatible even if this number is different.

④ Overload standard setting press.  
Select from the table below. Unification of the overload pressure at the press design stage facilitates the equipment control.

Note: Mark ● shows the model that can be manufactured.

Overload standard working pressure (MPa)	Press. code		
	5	6	7
16.0	●		
17.0	●		
18.0	●	●	
19.0	●	●	
20.0	●	●	●
21.2	●	●	●
22.5	●	●	●
23.5	●	●	●
25.0	●	●	●
26.5		●	●
28.0		●	●
30.0		●	●
31.5			●
33.5			●
35.5			●

- ① Body size (Orifice area)
  - 16 : 1.0 cm<sup>2</sup> × 2
  - 35 : 4.9 cm<sup>2</sup> × 2
- ② Overload pressure code (Max. value)
  - 5 : 25 MPa
  - 6 : 30 MPa
  - 7 : 35 MPa
- ③ Preload pressure
  - S : Standard
  - H \*1 : High pressure (Special)
- ④ Overload setting pressure (The first decimal place is indicated in MPa value)
  - ex.: 235 : 23.5 MPa
  - 300 : 30.0 MPa
- ⑤ Unit selection ※ SI unit (MPa) is recommended for a new order.
  - P : MPa

### Remarks

\*1 : Whenever H type is desirable, consult us for detail.

### Specifications

Body size		PW16			PW35					
Dimension (X×Y×Z) mm		321.5×122×104			200×160×135					
Overload pressure code		5	6	7	5	6	7			
Orifice area cm <sup>2</sup>		1×2			4.9×2					
Rating flow rate cm <sup>3</sup> /s		22,000×2	24,000×2	26,000×2	100,000×2	105,000×2	110,000×2			
Overload pressure setting range	S	Air supply pressure for pump	0.4	16~25	18~30	20~35.5	16~25	18~30	20~35.5	
			0.45	18~25						
			0.5				18~25			
	MPa	H	Air supply pressure for pump	0.35	-	18~30	20~35.5	-	18~30	20~35.5
				0.4	-	21.2~30	21.2~35.5	-	21.2~30	21.2~35.5
				0.45	-	23.5~30	23.5~35.5	-	23.5~30	23.5~35.5
			0.5	-	26.5~30	26.5~35.5	-	26.5~30	26.5~35.5	
Air supply press. MPa	Preload press.	S	0.4~0.5			-				
H		0.35~0.5			-					
Pump discharge press. MPa	S	24×(Air pressure -0.04)			-					
	H	38×(Air pressure -0.04)			-					
Operating temperature		-5~70°C(However freezing not allowable)								
Operating fluid		ISO-VG-15~ISO-VG-32								
Mass kg		10			20					

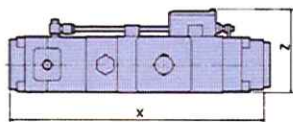

PW16

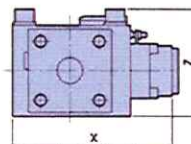
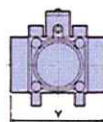

PW35  
(Pump is optional)

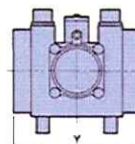

※ See the separate outline drawing for detail dimension.

# PW Series

# KOLP



Spring type multi-load model

## Model designation

PW 35 6 Q - S 265 K ※

①            ②            ③            ④            ⑤

Design No.

**kgf/cm<sup>2</sup>**

※ is our control number.  
Compatible even if this number is different.

④ Overload standard setting press. Select from the table below. Unification of the overload pressure at the press design stage facilitates the equipment control.

Note: Mark ● shows the model that can be manufactured.

Overload standard working pressure (kgf/cm <sup>2</sup> )	Press. code		
	5	6	7
160	●		
170	●		
180	●	●	
190	●	●	
200	●	●	●
212	●	●	●
225	●	●	●
235	●	●	●
250	●	●	●
265		●	●
280		●	●
300		●	●
315			●
335			●
355			●

- ① Body size (Orifice area)
  - 16 : 1.0 cm<sup>2</sup> × 2
  - 35 : 4.9 cm<sup>2</sup> × 2
- ② Overload pressure code (Max. value)
  - 5 : 250 kgf/cm<sup>2</sup>
  - 6 : 300 kgf/cm<sup>2</sup>
  - 7 : 355 kgf/cm<sup>2</sup>
- ③ Preload pressure
  - S : Standard
  - H \*1 : High pressure (Special)
- ④ Overload setting pressure (Three digits are indicated in kgf/cm<sup>2</sup> value.)
  - ex.: 250 : 250 kgf/cm<sup>2</sup>
  - 265 : 265 kgf/cm<sup>2</sup>
- ⑤ Unit selection ※ SI unit (MPa) is recommended for a new order.
  - K : kgf/cm<sup>2</sup>

### Remarks

\*1: Whenever H type is desirable, consult us for detail.

## Specifications

Body size		PW16			PW35				
Dimension (X×Y×Z) mm		321.5×122×104			200×160×135				
Overload pressure code		5	6	7	5	6	7		
Orifice area cm <sup>2</sup>		1×2			4.9×2				
Rating flow rate cm <sup>3</sup> /s		22,000×2	24,000×2	26,000×2	100,000×2	105,000×2	110,000×2		
Overload pressure setting range kgf/cm <sup>2</sup>	S	Air supply pressure for pump	4	160~250	180~300	200~355	160~250	180~300	200~355
			4.5	180~250			180~250		
			5						
	H	Air supply pressure for pump	3.5	-	180~300	200~355	-	180~300	200~355
			4	-	212~300	212~355	-	212~300	212~355
			4.5	-	235~300	235~355	-	235~300	235~355
5	-	265~300	265~355	-	265~300	265~355			
Air supply press. kgf/cm <sup>2</sup>	Preload press.	S	4~5			-			
		H	3.5~5			-			
Pump discharge press. kgf/cm <sup>2</sup>	Preload press.	S	24×(Air pressure -0.04)			-			
		H	38×(Air pressure -0.04)			-			
Operating temperature		-5~70°C(However freezing not allowable)							
Operating fluid		ISO-VG-15~ISO-VG-32							
Mass kg		10			20				

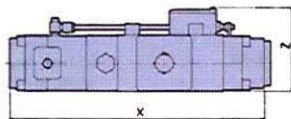

PW16

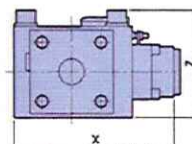
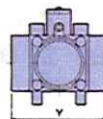

PW35  
(Pump is optional)

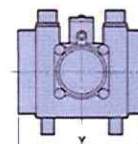

※ See the separate outline drawing for detail dimension.

## ■ KOLP tank manufacturing instruction

An oil tank should be manufactured by the customer according to the following notes:

### Important notes

- ★ The tank should be rigid against vibration and shock because it is mounted on the press slide.
- ★ Be sure to install a buffer plate between the suction filter and the oil return port to prevent white turbidity caused by return oil and blowout from the oil supply port.
- ★ It is recommended to design the tank shape so that the tank can be installed near Overload Cylinder.
- ★ The tank volume should be more than four times Overload Cylinder volume.

#### ● Example of small tank

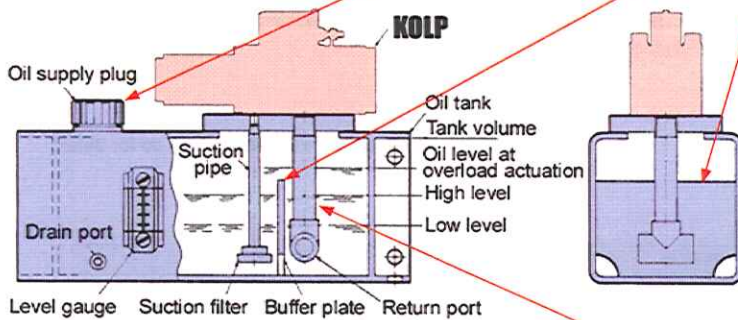

★ Be sure to use an oil supply plug with vent. Be sure to separate the oil return port from the oil supply plug by a buffer plate

★ Be sure to install a buffer plate between the oil return port and the pump suction port. Return oil is rapidly discharged to agitate the whole amount of hydraulic oil in the tank and cause white turbidity of oil. This oil containing a large amount of air is pumped into Overload Cylinder to cause erroneous action (response speed deterioration) or air penetration into the pump.

★ Consider the volume change of hydraulic oil in the tank sufficiently. Overflow caused by discharge at the overload actuation raises the pressure in the tank extraordinarily and may break the tank. If an excessive amount of oil is supplied, the similar situation occurs. Manufacture a rigid tank to prevent an unexpected accident. If an amount of oil is insufficient, the pump may suck air to cause trouble. Install an appropriate oil level gauge to keep the amount of oil proper.

★ Use Sch 80 pipe for the oil return port. Insufficient pipe strength may cause breakage of pipe thread portion or pipe bending, and may lead to abnormal function.

#### ● Example of large tank

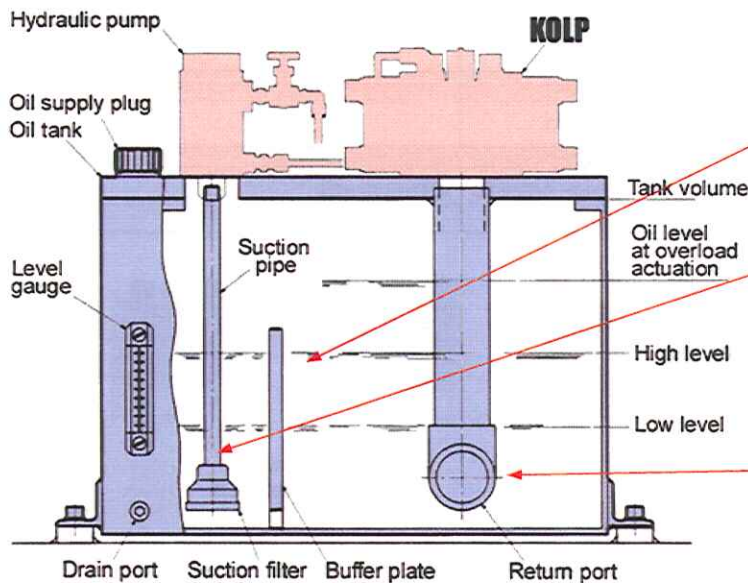

★ Install a buffer plate. Consider layout of the oil return port, oil supply plug and oil level gauge sufficiently in the manner similar to the small tank.

★ Be sure to provide a suction filter at the suction port of the pump.  
※(Optional parts available)  
Since screwed type suction pipe and return pipe are used, be sure to use Sch 80 pipe to secure sufficient strength.

★ It is recommended to attach a T-shape fitting to the oil return port to branch off discharge port. This will eliminate bending force caused by oil blowout. Always use Sch 80 pipe.

## Notes for application

- ① Connect **KOLP** and Overload Cylinder of the press surely with steel pipe. Minimize piping distance and number of bending point. When applying hose piping, consider effects by hose design pressure, inner diameter of hose and fitting, and expansion by hose pressure.
- ② Use piping size as large as possible referring to the table below.

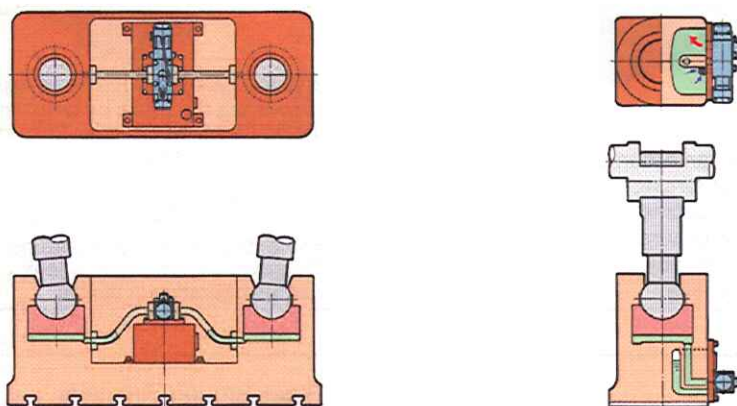

- ③ Always use bite type or weld type fitting (Threaded pipes of the size shown in the table cannot be used).
- ④ Always use piping specified in the table below.
- ⑤ Always use specified hydraulic oil. ※ See hydraulic oil list.
- ⑥ In case of cold weather, use low viscosity oil. The viscosity exceeding the specification lowers the flow rate characteristic, and adversely affects pump discharge and **KOLP** responsiveness.
- ⑦ Perform burr removal, acid cleaning and flushing to make piping free from dust and chips before conducting piping without fail.
- ⑧ Do not ride or put your foot on **KOLP**.
- ⑨ Do not touch limit switch because it has been adjusted before shipping. And in case of spring type, never readjust the overload pressure that has been already set.
- ⑩ Never provide limit switch with jumping or short circuit.
- ⑪ Before checking and repairing **KOLP**, turn OFF power supply to the press and fix the press slide.
- ⑫ Before removing **KOLP**, always relief the internal pressure of Overload Cylinder.

### ★Recommended piping size

Body size		10	16	35
		Piping size (Material)	Piping size (Material)	Piping size (Material)
Maximum operating pressure (MPa)	40	$\phi$ 15.3/ $\phi$ 21.7 (STS370) $\phi$ 12/ $\phi$ 18 (OST2)	$\phi$ 19.4/ $\phi$ 27.2 (STS370)	$\phi$ 21.2/ $\phi$ 34.0 $\phi$ 29.9/ $\phi$ 42.7 (STS370) $\phi$ 34.4/ $\phi$ 48.6
	35	$\phi$ 16.1/ $\phi$ 21.7 (STS370)	$\phi$ 20.4/ $\phi$ 27.2 (STS370)	$\phi$ 25.0/ $\phi$ 34.0 (STS370)
	32	$\phi$ 13/ $\phi$ 18 (OST2)	—	—
	30	—	$\phi$ 21.4/ $\phi$ 27.2 (STS370)	$\phi$ 32.9/ $\phi$ 42.7 (STS370)
	28	—	—	$\phi$ 38.4/ $\phi$ 48.6 (STS370)
	25	$\phi$ 14/ $\phi$ 18 (OST2)	—	—

\*Select piping size as large as possible within the strength range corresponding to the operating pressure.

## Peripheral equipment and device for press

### PF Type Overload Protection Valve



A safety valve with an action check switch for the small press for discharging hydraulic oil in Overload Cylinder automatically and instantly at the press overload generation, and sending an emergency stop signal by an attached proximity switch at the same time.

### Jamming Release Unit



A pump unit with a pressure relief valve for recovering the press by removing hydraulic oil inside Overload Cylinder from the condition where the press cannot be turned both normally and reversely due to seizure of the press caused by improper material feed during the press work or material defect. A bleeding valve for preventing internal pressure rise in Overload Cylinder due to temperature rise during normal operation is built in.

### Load Monitor



To be installed on Overload Cylinder to measure press work load. Helpful for quality control of press products by fully utilizing the press capacity and detecting a load change due to material property variation and mold degradation to facilitate to predict maintenance timing and to stabilize manufacturing process.

### Breakthrough Simulator

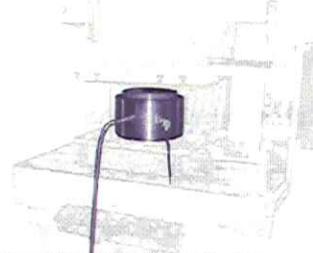

Unit for generating breakthrough phenomenon that arises during punching of a material. Since tests can be conducted without actually punching a material, repetitive tests or punching load changing can be easily performed. And the inspection in the same condition as in the factory before shipping can be performed on site because of its compactness. Helpful as a development tool to improve endurance of each part of the press and to reduce time and cost spent for dynamic accuracy inspection of the press.

### AA and AB Pumps



Reciprocating plunger type continuous discharge booster pump exclusively used for pressure retaining circuit. Using compressed air as power source, they generate 10 to 90 times the air pressure that is set and supplied by an air regulator. Energy consumption is very low because they automatically stop when air supply pressure balances with discharge pressure using an air-hydro booster as a base device.



HEAD OFFICE: 1-5, MURODANI 2-CHOME, NISHIKU, KOBE, JAPAN 651-2241  
TEL.81-78-991-5115 FAX.81-78-991-8787

BRANCH OFFICE: KOSMEK(U.S.A.) LTD.  
9824 S.INDUSTRIAL DRIVE SUITE B.BRIDGEVIEW, ILLINOIS 60455, U.S.A.  
TEL.1-708-598-5772 FAX.1-708-598-6215

- Contact us for specifications and dimensions not described in this catalog.
- The contents of this catalog are subject to change without notice.

CAT. NO. PZ-02-02. 2000.08 First  
2005.12 Second